

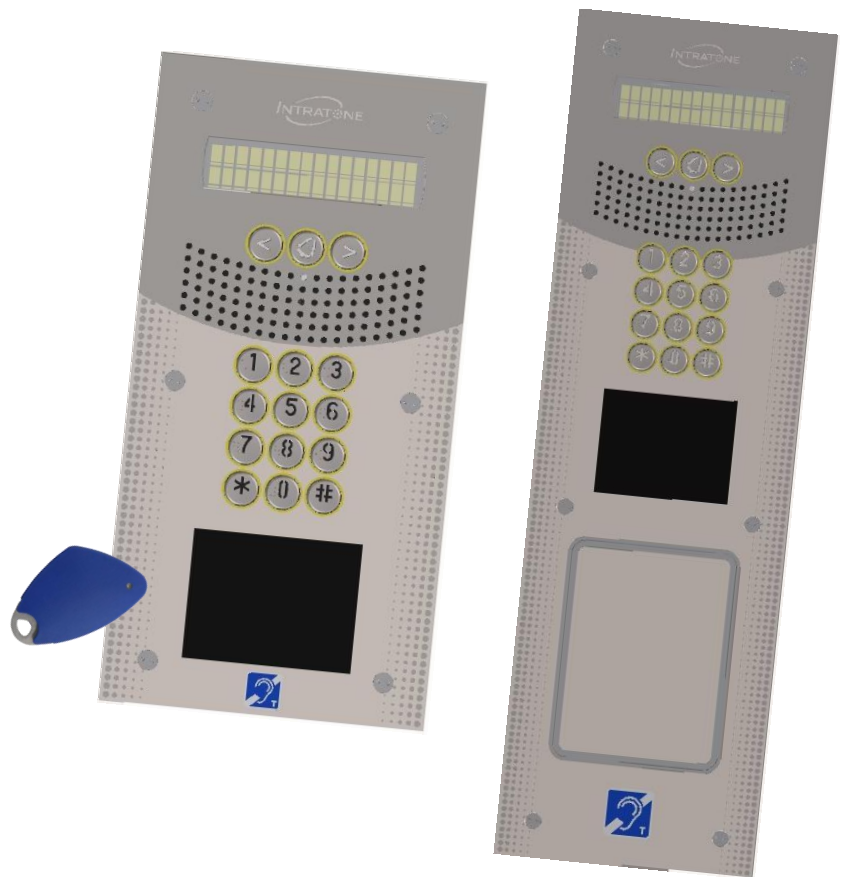

02-0182 - 02-0193



**INTERPHONE VIDÉO V4**

**V4 VIDEO INTERCOM**

**VIDEO-GEGENSPRECHANLAGE V4**

**VIDEO-INTERCOM V4**

**INTERFONO VÍDEO V4**



**INTRATONE**  
ZI de Maunit 370 rue de Maunit  
85290 MORTAGNE SUR SEVRE  
FRANCE

AUDIO CALL / APPEL AUDIO / AUDIOANRUF / AUDIO CALL / LLAMADA DE AUDIO



**3G Module**  
**17-0101**



**4G IP Module**  
**17-0233**



VIDEO CALL / APPEL VIDEO / VIDEOANRUF / VIDEO CALL / VIDEO LLAMADA



3G Module  
17-0101

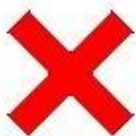

4G IP Module  
17-0233

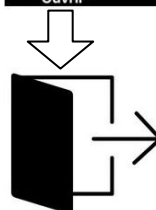
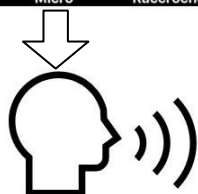
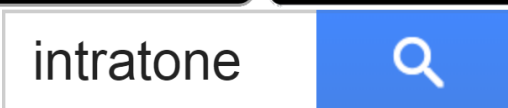

Ref : 02-0182 / 02-0183

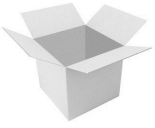

X 6



X 1



X 2

Ref : 02-0189

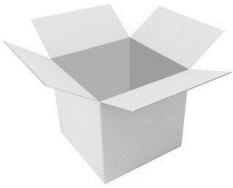

X 8



X 1



X 2



X 3

**Lecteur de proximité mains-libres / Hands-free proximity reader / Handsfree Transponder  
Lese-Einheit / Handsfree proximity-lezer / Lector de proximidad manos libres**

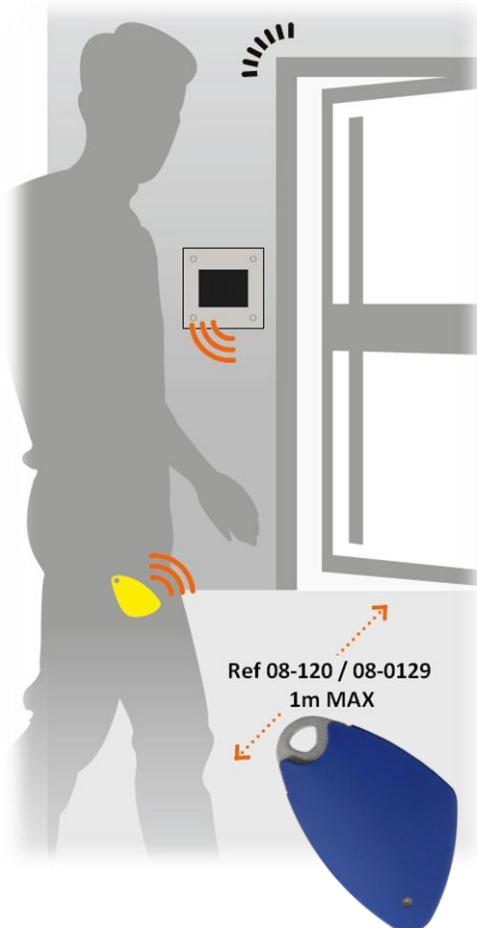

# DIMENSIONS

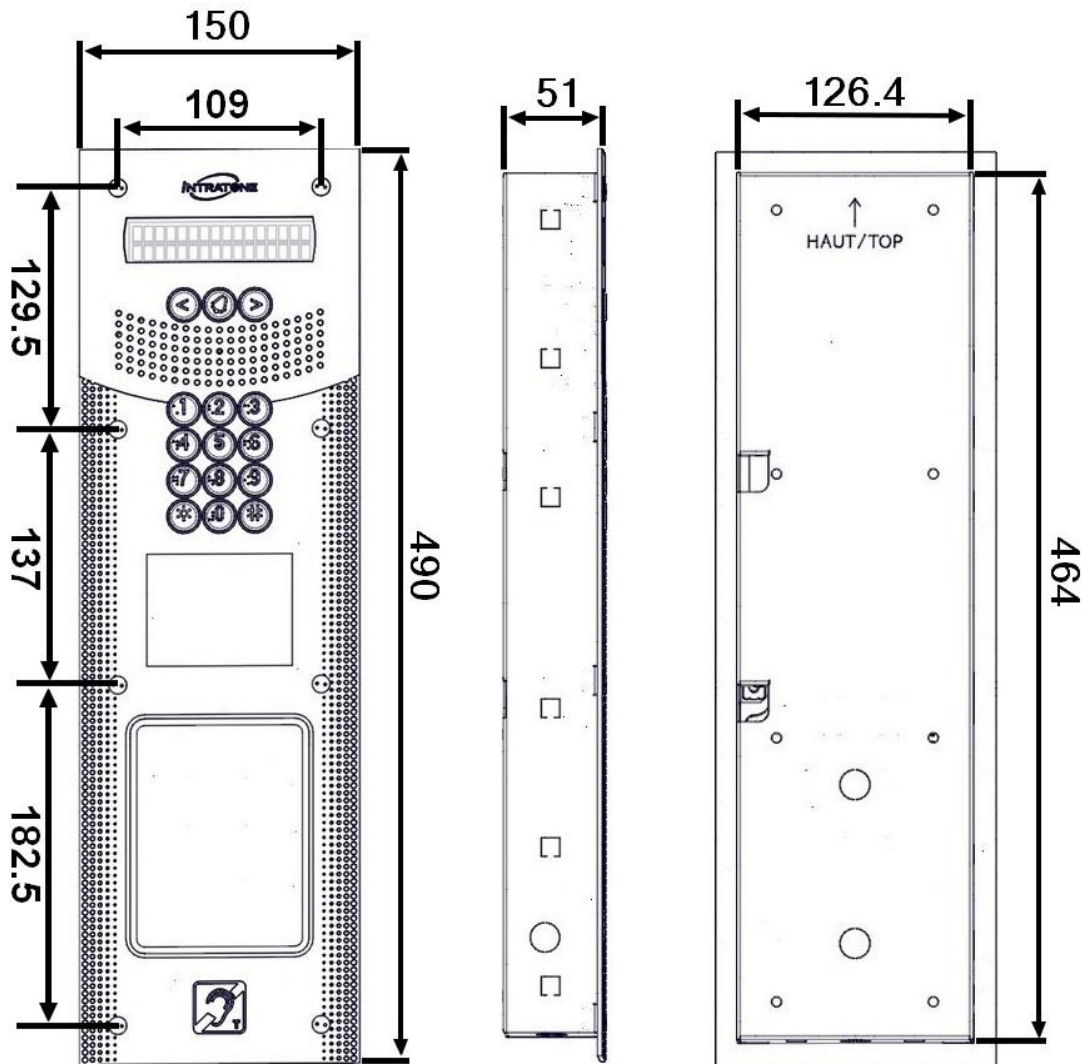
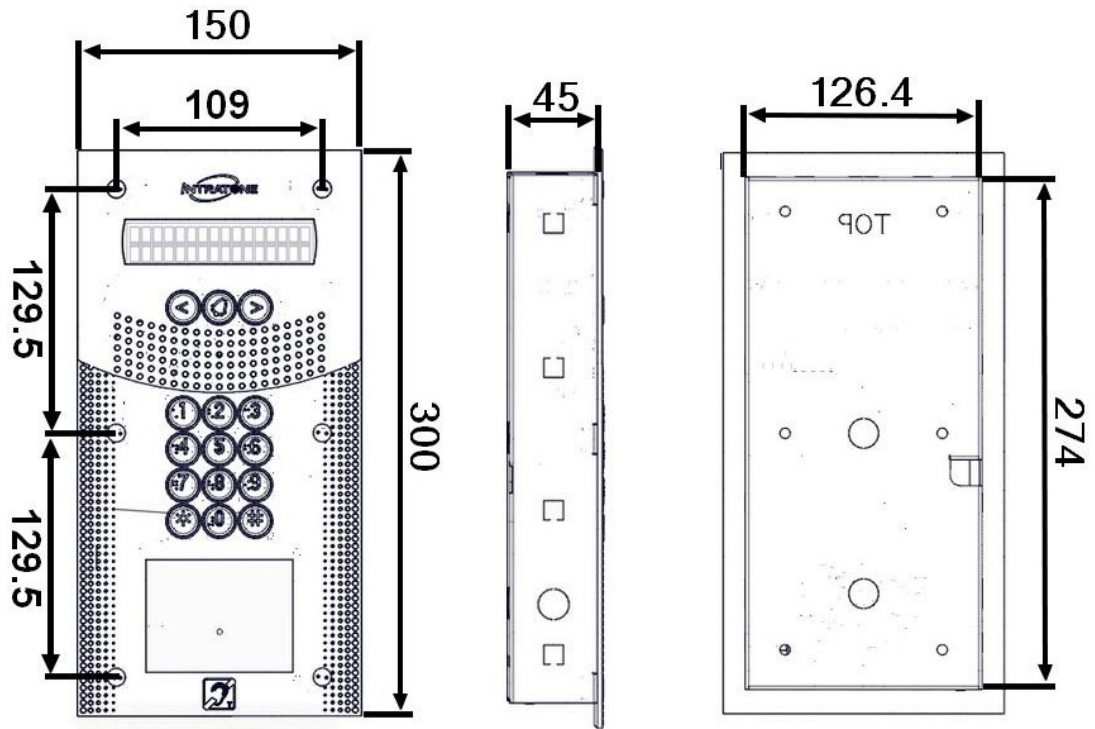

L'interphone possède une charnière qui facilite les interventions, elle est démontable.

The intercom has a hinge that facilitates interventions, it is removable.

Die Gegensprechanlage hat ein Scharnier, das Eingriffe erleichtert, es ist abnehmbar.

De intercom heeft een scharnier dat ingrepen vergemakkelijkt, het is verwijderbaar.

El intercom tiene una bisagra que facilita las intervenciones, es extraíble.

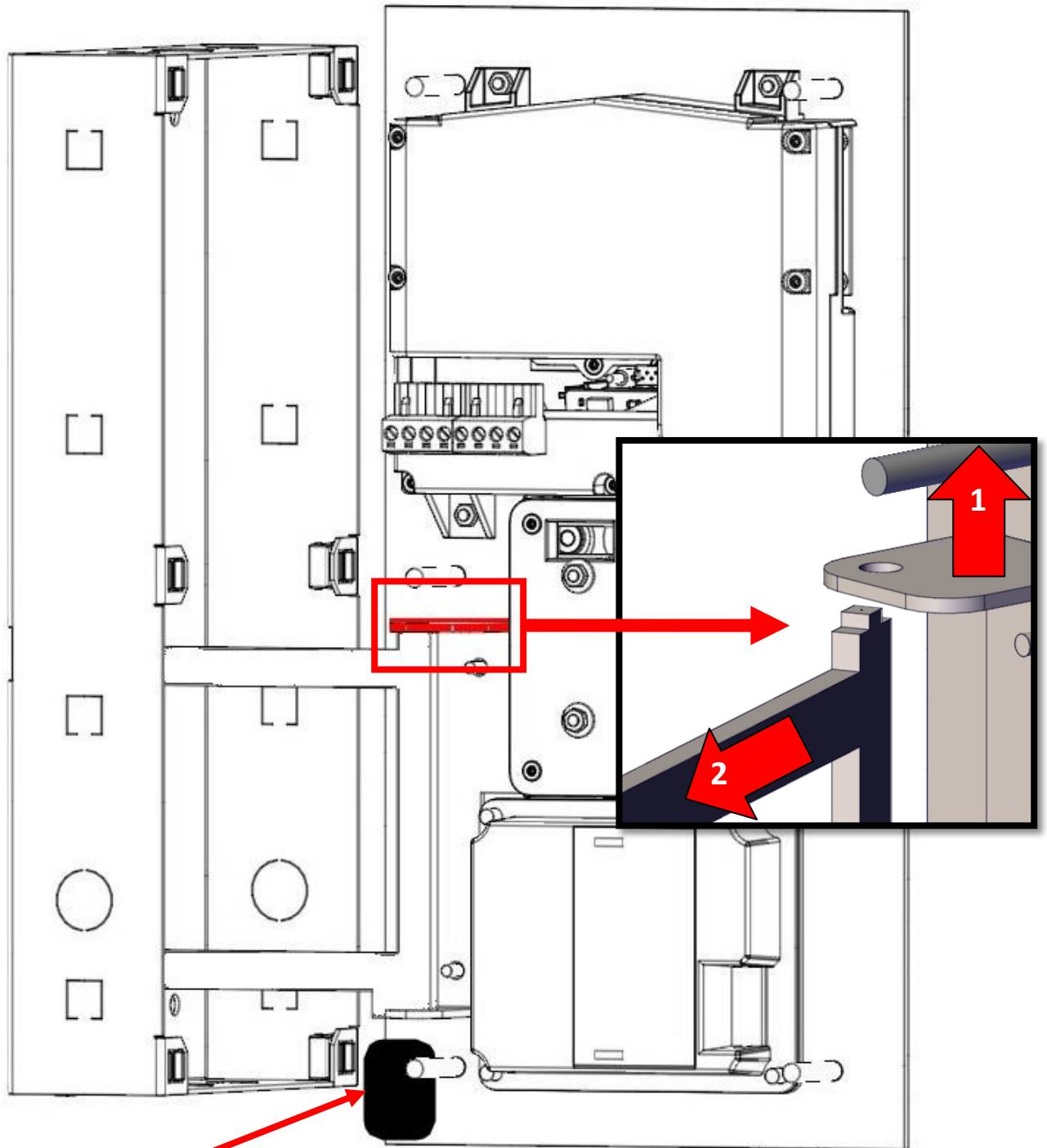

**Cale de protection à retirer avant de fermer l'interphone.**

**Shim to remove before closing the intercom.**

**Shim zu entfernen, bevor Sie die Gegensprechanlage schließen.**

**Pas op om te verwijderen voordat de intercom wordt gesloten.**

**Calce para quitar antes de cerrar el intercomunicador.**



03-0102

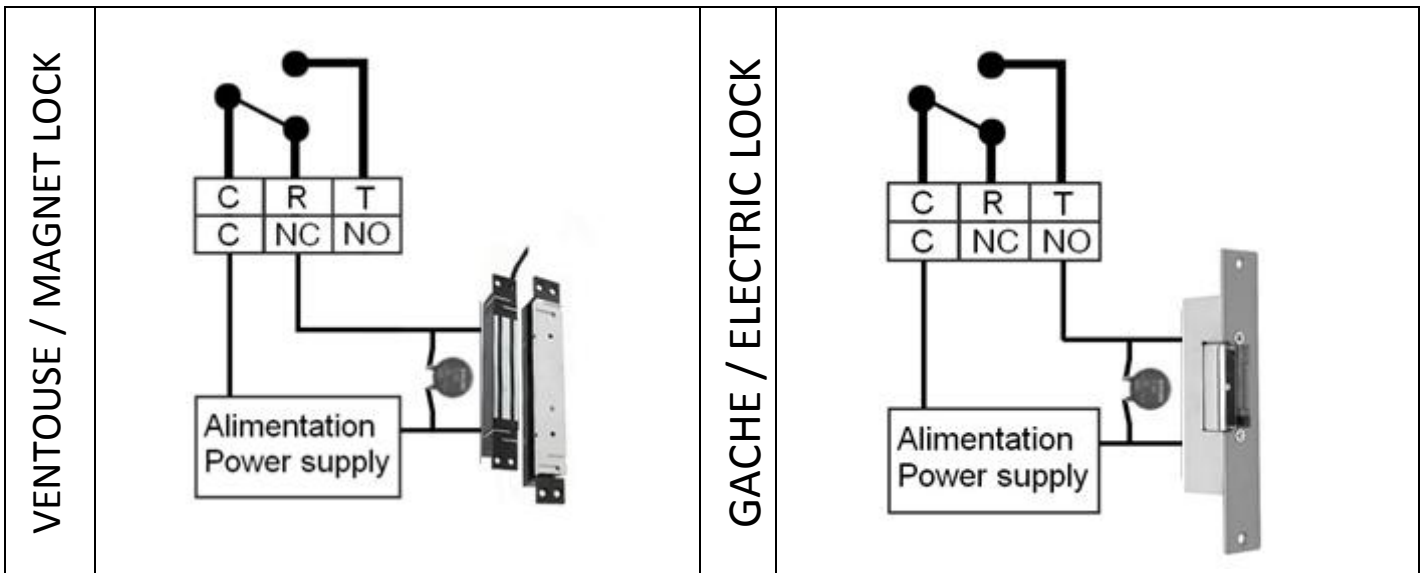
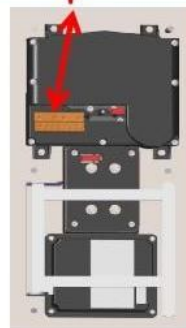
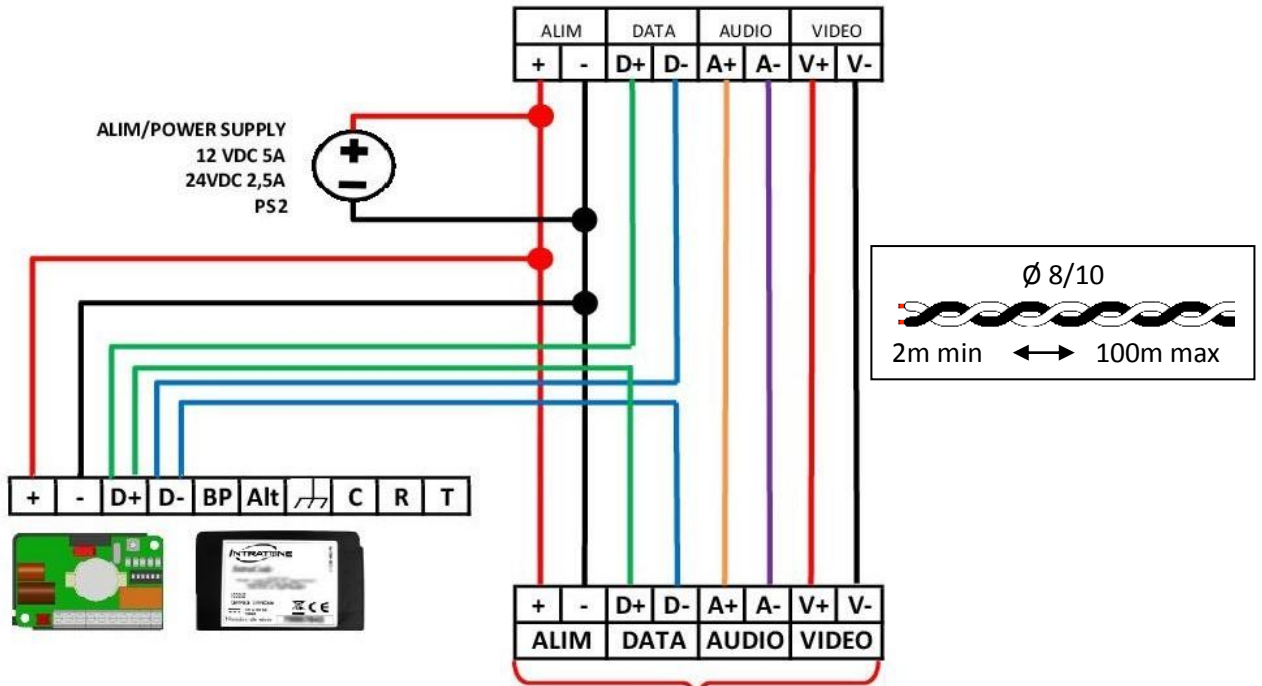

03-0101

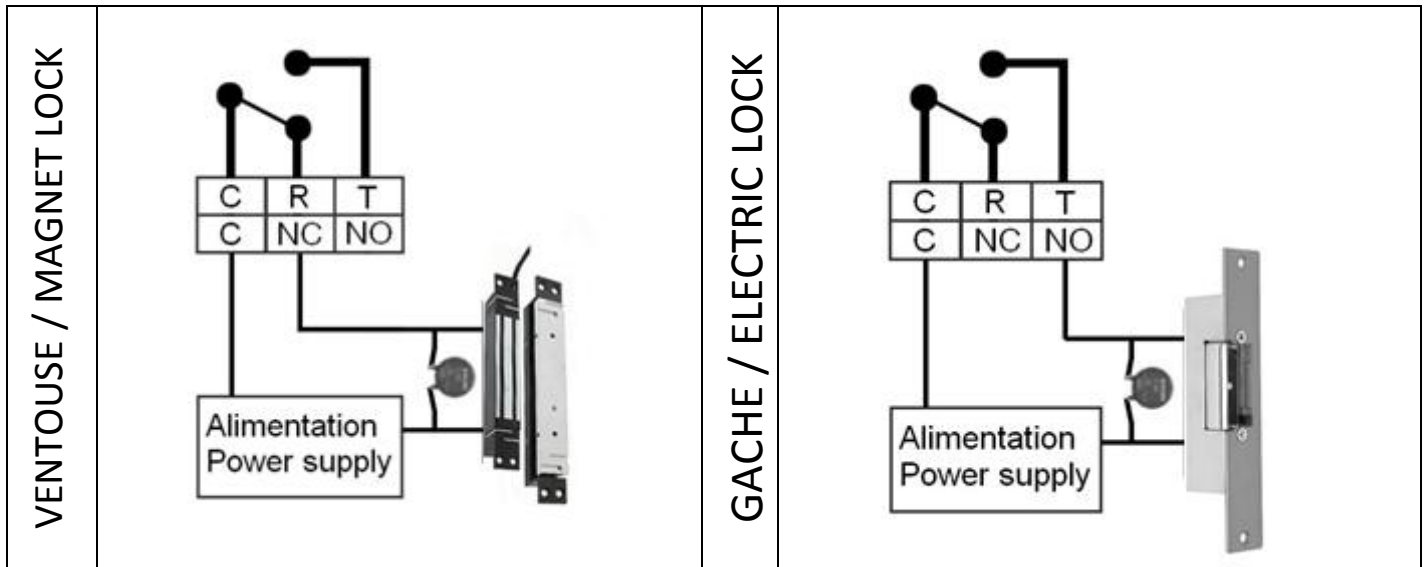
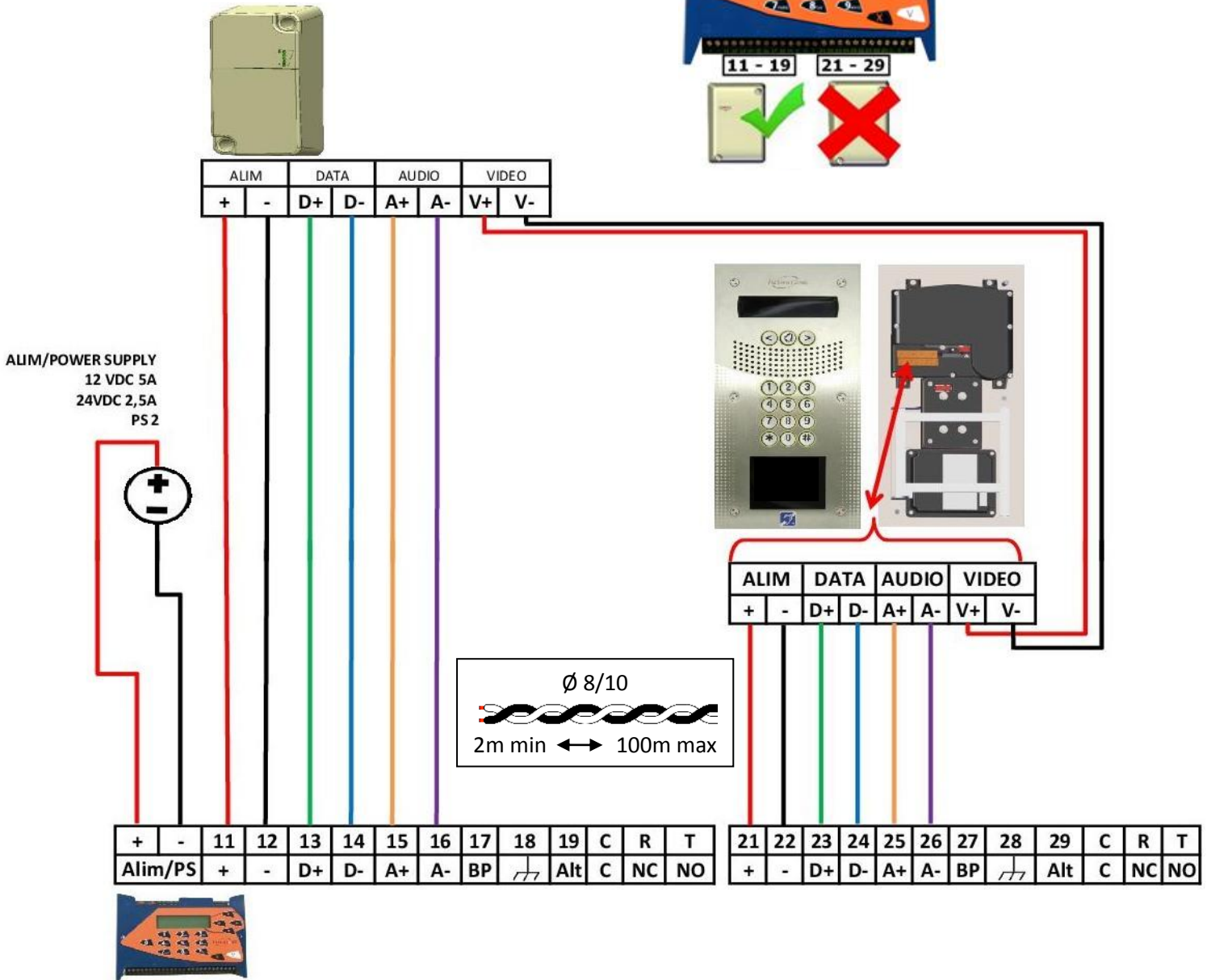



Réception réseau / Network reception / Netzwerkkempfang / Netwerk ontvangst /  
Recepción de red

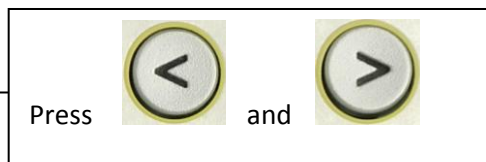

**RES 3G**

	AUDIO CALL	VIDEO CALL
RES GSM	✓	✗
RES 3G	✓	✓
RES 4G	✓	✓

**NIV 17 3**

Le premier chiffre donne le niveau sur 30 (Ici 17/30)	Le second chiffre donne le niveau sur 5 (Ici 3/5)
The first digit gives the level out of 30 (Here 17/30)	The second digit gives the level out of 5 (Here 3/5)
Die erste Ziffer gibt das Level von 30 (hier 17/30)	Die zweite Ziffer gibt die Stufe von 5 (hier 3/5)
Het eerste cijfer geeft het niveau uit 30 (hier 17/30)	Het tweede cijfer geeft het niveau van 5 (Here 3/5)
El primer dígito da el nivel de 30 (Aquí 17/30)	El segundo dígito da el nivel de 5 (Aquí 3/5)



## GESTION SUR [www.intratone.info](http://www.intratone.info)

- 1 : Créez votre « Résidence » simplifiée ou complexe
- 2 : Créez votre interphone V4 et configurez la centrale
- 3 : Créez vos logements. Vos badges et résidents seront à l'intérieur
- 4 : Cliquez « Mettre à jour » sur la page « Résidences » lorsque vous avez terminé.

### COFFRE A CLES

3 Etiktronik sont fournis avec la platine V4 02-0189



	<p>Sur <a href="http://www.intratone.info">www.intratone.info</a> → rubrique « Coffre à clés »</p> <ul style="list-style-type: none"><li>- Choisissez le coffre à clé qui porte le nom de votre interphone</li><li>- Vous arrivez sur <a href="http://www.organigramme.info">www.organigramme.info</a></li><li>- Vous allez pouvoir créer un « Agent » en lui attribuant Badge et Code.</li><li>- Pensez à lui donner l'accès à votre coffre à clé.</li><li>- La mise à jour va se faire automatiquement.</li></ul> <p><b>Pour ouvrir le coffre à clé :</b></p> <ul style="list-style-type: none"><li>- Posez le badge Pass devant la tête de lecture pendant au moins 5 sec. OU</li><li>- Tapez le code sur le clavier de la platine</li></ul>
	<p>Sur <a href="http://www.intratone.info">www.intratone.info</a></p> <ul style="list-style-type: none"><li>- Allez dans la rubrique « Codes » et sélectionner votre interphone.</li><li>- Choisir « Ajouter » dans la rubrique « Codes téléphoniques »</li><li>- Choisir votre code et cocher la case « Ouvre le coffre à clés »</li><li>- Faites une mise à jour « temps réel » du matériel</li></ul> <p><b>Devant le coffre à clés :</b></p> <ul style="list-style-type: none"><li>- Un intervenant se présente devant la platine et vous appelle.</li><li>- Vous répondez et tapez le code sur le clavier de votre téléphone.</li><li>- Le coffre à clés se déverrouille à distance.</li></ul>
	<p>Sur <a href="http://www.intratone.info">www.intratone.info</a> → rubrique « Coffre à clés »</p> <ul style="list-style-type: none"><li>- Choisissez le coffre à clé qui porte le nom de votre interphone</li><li>- Vous arrivez sur <a href="http://www.organigramme.info">www.organigramme.info</a></li><li>- Choisir « Vos alarmes » et « + Créer une alarme »</li><li>- Vous pouvez choisir d'être prévenu par mail : D'un problème sur le coffre à clé ou qu'un trousseau de clé n'a pas été rendu.</li></ul>





# MANAGEMENT ON [www.intratone.info](http://www.intratone.info)

- 1: Create your simplified or complex "Residence"
- 2: Create your V4 intercom and configure the control panel
- 3: Create your homes. Your badges and residents will be inside
- 4: Click "Update" on the "Residences" page when you are done.

## KEY CHEST

3 Etiktronik are provided with the intercom V4 02-0189



	<p>On <a href="http://www.intratone.info">www.intratone.info</a> → heading "Key safe"</p> <ul style="list-style-type: none"> <li>- Choose the key box that bears the name of your intercom</li> <li>- You arrive on <a href="http://www.organigramme.info">www.organigramme.info</a></li> <li>- You will be able to create an "Agent" by assigning him Badge and Code.</li> <li>- Remember to give him access to your locker.</li> <li>- The update will be done automatically.</li> </ul> <p><b>To open the safe:</b></p> <ul style="list-style-type: none"> <li>- Place the Pass badge in front of the reading head for at least 5 seconds.</li> <li>OR</li> <li>- Type the code on the keyboard of the turntable</li> </ul>
	<p>On <a href="http://www.intratone.info">www.intratone.info</a></p> <ul style="list-style-type: none"> <li>- Go to the "Codes" section and select your intercom.</li> <li>- Choose "Add" in the "Telephone codes" section</li> <li>- Choose your code and check the box "Open the key box"</li> <li>- Do a "real time" update of the material</li> </ul> <p><b>In front of the key box:</b></p> <ul style="list-style-type: none"> <li>- A speaker comes to the turntable and calls you.</li> <li>- You answer and type the code on the keypad of your phone.</li> <li>- The key box unlocks at a distance.</li> <li>-</li> </ul>
	<p>On <a href="http://www.intratone.info">www.intratone.info</a> → heading "Key safe"</p> <ul style="list-style-type: none"> <li>- Choose the key box that bears the name of your intercom</li> <li>- You arrive on <a href="http://www.organigramme.info">www.organigramme.info</a></li> <li>- Choose "Your alarms" and "+ Create an alarm"</li> <li>- You can choose to be notified by mail: A problem on the key box or a keychain has not been made.</li> </ul>



# MANAGEMENT AUF [www.intratone.info](http://www.intratone.info)

- 1: Erstellen Sie Ihre vereinfachte oder vollständige "Residenz"
- 2: Erstellen Sie Ihre V4 Gegensprechanlage und konfigurieren Sie das Bedienfeld
- 3: Erstellen Sie Ihre Wohnungen. In diesen dann die Bewohner und Transponder bzw. Codes.
- 4: Klicken Sie auf "Aktualisieren" auf der Seite "Residences", wenn Sie fertig sind.

## SCHLÜSSELKASTEN

**3 Etiktronik sind mit der Gegensprechanlage zur Verfügung gestellt V4 02-0189**



	<p><b>Auf der <a href="http://www.intratone.info">www.intratone.info</a> → Rubrik " Schlüsselkästen "</b></p> <ul style="list-style-type: none"> <li>- Wählen Sie einen Schlüsselsafe und dann einen programmierten Badge der diesen Tresor öffnet.</li> <li>- Sie kommen auf <a href="http://www.organigramme.info">www.organigramme.info</a> an</li> <li>- Führen Sie jetzt eine Echtzeit Aktualisierung durch um Ihre Badges in dem Programm zu implementieren.</li> </ul> <p><b>Schlüsselbox:</b> Halten Sie den Badge für mindestens 5 Sekunden vor den Lesekopf an Ihrer Sprechanlage oder Schlüsseltresor oder geben Sie den Tastaturcode zum Öffnen ein.</p> <ul style="list-style-type: none"> <li>- Die Schlüsselbox wird entsperrt und Sie hören einen Warnton.</li> </ul>
	<p><b>Auf der <a href="http://www.intratone.info">www.intratone.info</a> → Rubrik " Schlüsselkästen "</b></p> <ul style="list-style-type: none"> <li>- Wählen Sie einen Schlüsseltresor und hinterlegen Sie einen 4 stelligen Telefoncode zum Öffnen auf der Website.</li> <li>- Führen Sie jetzt eine Echtzeit Aktualisierung durch um Ihre Codes in dem Programm zu implementieren.</li> </ul> <p><b>Schlüsselbox:</b></p> <ul style="list-style-type: none"> <li>- Das hinterlegte Mobiltelefon ruft die Anlage mit dem richtigen Code an.</li> <li>- Die Schlüsselbox wird entsperrt und Sie hören einen Warnton.</li> </ul>
	<p><b>Auf der <a href="http://www.intratone.info">www.intratone.info</a> → Rubrik " Schlüsselkästen "</b></p> <ul style="list-style-type: none"> <li>- Sie hinterlegen eine E-Mail Adresse auf der Website.</li> </ul> <p><b>Schlüsselbox :</b></p> <ul style="list-style-type: none"> <li>- Wird die Schlüsselbox geöffnet, ein Schlüssel entnommen oder zurückgebracht, wird in Echtzeit die von Ihnen ausgewählte E-Mail Adresse informiert.</li> </ul>





## MANAGEMENT OP [www.intratone.info](http://www.intratone.info)

- 1: Maak uw vereenvoudigde of complexe "Woonplaats"
- 2: Maak uw V4-intercom en configureer het bedieningspaneel
- 3: Maak je huizen. Je badges en bewoners zullen binnen zijn
- 4: Klik op "Update" op de pagina "Residences" als u klaar bent.

### BELANGRIJKSTE BORST

#### 3 Etiktronik worden geleverd met V4-kaart 02-0189



	<p>Op <a href="http://www.intratone.info">www.intratone.info</a> → rubriek "Sleutel veilig"</p> <ul style="list-style-type: none"><li>- Kies het sleutelkastje dat de naam van uw intercom draagt</li><li>- U komt op <a href="http://www.organigramme.info">www.organigramme.info</a></li><li>- U kunt een "Agent" maken door hem Badge en Code toe te wijzen.</li><li>- Vergeet niet om hem toegang te geven tot je kluisje.</li><li>- De update wordt automatisch uitgevoerd.</li></ul> <p><b>Om de kluis te openen:</b></p> <ul style="list-style-type: none"><li>- Plaats de Pass-badge voor de leeskop gedurende minstens 5 seconden.</li></ul> <p><b>OR</b></p> <ul style="list-style-type: none"><li>- Typ de code op het toetsenbord van de draaitafel</li></ul>
	<p>Op <a href="http://www.intratone.info">www.intratone.info</a></p> <ul style="list-style-type: none"><li>- Ga naar het gedeelte "Codes" en selecteer uw intercom.</li><li>- Kies "Toevoegen" in het gedeelte "Telefooncodes"</li><li>- Kies uw code en vink het vakje aan "Open het sleutelkastje"</li><li>- Voer een "real-time" update van het materiaal uit</li></ul> <p><b>Voor het sleutelkastje:</b></p> <ul style="list-style-type: none"><li>- Er komt een luidspreker naar de draaitafel en belt u.</li><li>- U beantwoordt en typt de code op het toetsenbord van uw telefoon.</li><li>- Het sleutelkast ontgrendelt op afstand.</li></ul>
	<p>Op <a href="http://www.intratone.info">www.intratone.info</a> → rubriek "Sleutel veilig"</p> <ul style="list-style-type: none"><li>- Kies het sleutelkastje dat de naam van uw intercom draagt</li><li>- U komt op <a href="http://www.organigramme.info">www.organigramme.info</a></li><li>- Kies "Uw alarmen" en "+ Maak een alarm"</li><li>- U kunt ervoor kiezen per e-mail op de hoogte te worden gesteld: Er is geen probleem met het sleutelkastje of met een sleutelhanger.</li></ul>





## GESTIÓN EN [www.intratone.info](http://www.intratone.info)

- 1: Crea tu "Residencia" simplificada o compleja
- 2: crea tu intercomunicador V4 y configura el panel de control
- 3: crea tus casas. Sus insignias y residentes estarán dentro
- 4: haga clic en "Actualizar" en la página "Residencias" cuando haya terminado.

### PECHO CLAVE

#### 3 Etiktronik se suministran con placa V4 02-0189

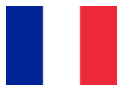

	<p>En <a href="http://www.intratone.info">www.intratone.info</a> → encabezado "Clave seguro"</p> <ul style="list-style-type: none"><li>- Elija el cuadro de llave que lleva el nombre de su intercomunicador</li><li>- Llegas a <a href="http://www.organigramme.info">www.organigramme.info</a></li><li>- Podrá crear un "Agente" asignándole Insignia y Código.</li><li>- Recuerda darle acceso a tu casillero.</li><li>- La actualización se hará automáticamente.</li></ul> <p><b>Para abrir la caja fuerte:</b></p> <ul style="list-style-type: none"><li>- Coloque la insignia de pase delante del cabezal de lectura durante al menos 5 segundos. Oregón</li><li>- - Escriba el código en el teclado de la plataforma giratoria</li></ul>
	<p>En <a href="http://www.intratone.info">www.intratone.info</a></p> <ul style="list-style-type: none"><li>- Vaya a la sección "Códigos" y seleccione su intercomunicador.</li><li>- Elija "Agregar" en la sección "Códigos telefónicos"</li><li>- Elija su código y marque la casilla "Abrir el cuadro clave"</li><li>- Hacer una actualización en "tiempo real" del material</li></ul> <p><b>En frente de la caja de claves:</b></p> <ul style="list-style-type: none"><li>- Un altavoz llega al plato giratorio y te llama.</li><li>- Respondes y escribes el código en el teclado de tu teléfono.</li><li>- La caja de claves está desbloqueada de forma remota.</li></ul>
	<p>En <a href="http://www.intratone.info">www.intratone.info</a> → encabezado "Clave seguro"</p> <ul style="list-style-type: none"><li>- Elija el cuadro de llave que lleva el nombre de su intercomunicador</li><li>- Llegas a <a href="http://www.organigramme.info">www.organigramme.info</a></li><li>- Elija "Sus alarmas" y "+ Crear una alarma"</li><li>- Puede optar por recibir una notificación por correo: no se ha realizado un problema en el cuadro de la llave o un llavero.</li></ul>

**Garanties de fonctionnement:**

L' Interphone Vidéo V4 est garanti dans une plage de température comprise entre -20°C et +60°C et pour une humidité relative maximum de 70%.

Doit être posé selon le sens Haut / Bas préconisé sur l'appareil.

L'installation doit être réalisée par du personnel qualifié possédant les connaissances nécessaires à un montage sûr de l'équipement.

Ce kit comprend les éléments nécessaires pour assurer une installation sûre de l'équipement.

**Recyclage du produit en fin de vie:**

L' Interphone Vidéo V4 et ses accessoires ne doivent pas être mis au rebut avec les déchets municipaux non triés, mais doivent suivre la filière de collecte et de recyclage des produits DEEE (Déchets d'Equipements Electriques et Electroniques).

**Déclaration de conformité simplifiée**

Le soussigné, COGELEC, déclare que l'équipement radioélectrique du type contrôle d'accès pour l'habitat collectif est conforme à la directive 2014/53/UE (RED).Le texte complet de la déclaration UE de conformité est disponible à l'adresse internet suivante :

[www.intratone.fr/documentation](http://www.intratone.fr/documentation)

**Warranty operating guarantees:**

The V4 video intercom is guaranteed within a temperature range of -20°C and +60°C and at a relative humidity level not exceeding 70%.

It must be installed according to the Top/Bottom directions given in these instructions and on the device.

The installation must be carried out by qualified personnel with the necessary knowledge for a safe assembly of the equipment.

This kit includes the necessary elements to ensure a safe installation of the equipment.

**End-of-life recycling of the product:**

The V4 video intercom and its accessories must not be discarded with unsorted municipal waste, but must be disposed of via the WEEE (Waste Electrical and Electronic Equipment) collection and recycling system.

**Simplified declaration of conformity**

The undersigned, COGELEC, declares that access control type radio equipment for collective housing is in compliance with Directive 2014/53 / EU (RED).The full text of the EU declaration of conformity is available at the following internet

address:[www.intratone.fr/documentation](http://www.intratone.fr/documentation)

**Funktionsgarantien:**

Der Betrieb des Video-Gegensprechanlage V4 ist für eine Temperaturspanne zwischen -20 °C und +60 °C und für eine relative Luftfeuchtigkeit von 70 % gewährleistet.

Muss wie auf dem Gegensprechanlage angegeben in der Richtung Oben/Unten eingebaut werden.

Die Installation muss von qualifiziertem Personal mit den notwendigen Kenntnissen für eine sichere Montage der Ausrüstung durchgeführt werden.

Dieses Kit enthält die notwendigen Elemente, um eine sichere Installation des Geräts zu gewährleisten.

**Entsorgung des ausgedienten Geräts:**

Das Video-Gegensprechanlage V4 und sein Zubehör dürfen nicht mit unsortiertem Hausmüll entsorgt werden, sondern müssen an Sammel- und Recyclestellen für Elektro- und Elektronikgeräte-Abfall abgegeben werden.

**Vereinfachte Konformitätserklärung**

Der Unterzeichnete, COGELEC, erklärt, dass funkgesteuerte Zugangskontrollgeräte für den kollektiven Wohnungsbau der Richtlinie 2014/53 / EU (RED) entsprechen. Der vollständige Text der EU-Konformitätserklärung ist unter folgender

Internetadresse verfügbar: [www.intratone.fr/documentation](http://www.intratone.fr/documentation)



### **Werkingsgarantie:**

Het Video-intercom V4 werkt bij temperaturen tussen -20 °C et +60 °C en bij een relatieve vochtigheid van ten hoogste 70%.

Moet gemonteerd worden met de juiste zijden naar boven en onder, zoals aangegeven op het intercom.

De installatie moet worden uitgevoerd door gekwalificeerd personeel met de nodige kennis voor een veilige montage van de apparatuur.

Deze set bevat de nodige elementen om een veilige installatie van de apparatuur te garanderen.



### **Recycling aan het einde van de levensduur:**

Het Video-intercom V4 en zijn toebehoren mogen niet als restafval worden afgevoerd, maar moeten ingeleverd worden bij inzamelpunten voor elektrische of elektronische apparatuur.



### **Vereenvoudigde verklaring van overeenstemming**

Ondergetekende, COGELEC, verklaart dat radioapparatuur voor toegangscontrole voor collectieve huisvesting voldoet aan Richtlijn 2014/53 / EU (RED). De volledige tekst van de EU-conformiteitsverklaring is beschikbaar op het volgende internetadres: [www.intratone.fr/documentation](http://www.intratone.fr/documentation)



### **Garantías de funcionamiento:**

El Interfono vídeo V4 está garantizado en una franja de temperatura entre los -20 °C y los +60 °C y con una humedad relativa máxima del 70 %.

Debe colocarse con el sentido Arriba / Abajo que se indica en el interfono.

La instalación debe ser llevada a cabo por personal calificado con los conocimientos necesarios para un montaje seguro del equipo.

Este kit incluye los elementos necesarios para garantizar una instalación segura del equipo.



### **Reciclaje del producto una vez concluida su vida útil:**

No deseche el Interfono vídeo V4, ni los accesorios que incluye, junto con los residuos municipales orgánicos. Debe seguir el procedimiento de recogida y reciclaje dispuesto para los productos RAEE (Residuos de dispositivos Eléctricos y Electrónicos).



### **Declaración simplificada de conformidad**

El abajo firmante, COGELEC, declara que los equipos de radio de control de acceso para viviendas colectivas cumplen con la Directiva 2014/53 / UE (RED). El texto completo de la declaración de conformidad de la UE está disponible en siguiente dirección de internet: [www.intratone.fr/documentation](http://www.intratone.fr/documentation)